

tested down to
-40°C | -40°F

Front dimensions: Ø 36 mm
Panel cut-out: Ø 30.5 mm
Front bezel height: 2.7 mm
Travel: 6 mm





KOMBITAST-R-JUWEL

 Product configurator



KOMBITAST®-R-JUWEL

Ø 30.5 mm

MADE IN GERMANY



About Us

Pushbuttons and Switches

Panel Mount Jacks

Emergency-Stop Buttons

Bus Technology

RFD

Enclosures

Pedal Switches

Terminal Blocks

Type Index

Overview - KOMBITAST-R-JUWEL series



01 Pushbutton heads	page 328	07 Panel mount jacks	page 339
02 Emergency-stop heads	page 330	08 Pilot light heads / pilot lights	page 340
03 Knob set for rotary switches/potentiometers	page 333	Contact blocks/lampholders	page 414
04 Selector heads	page 334		
05 Toggle heads	page 336		
06 Key actuators	page 337		

Housing colours (silver-coloured, stainless steel, charcoal)



degree of protection



operating travel



tactile



illuminating option



labelling option



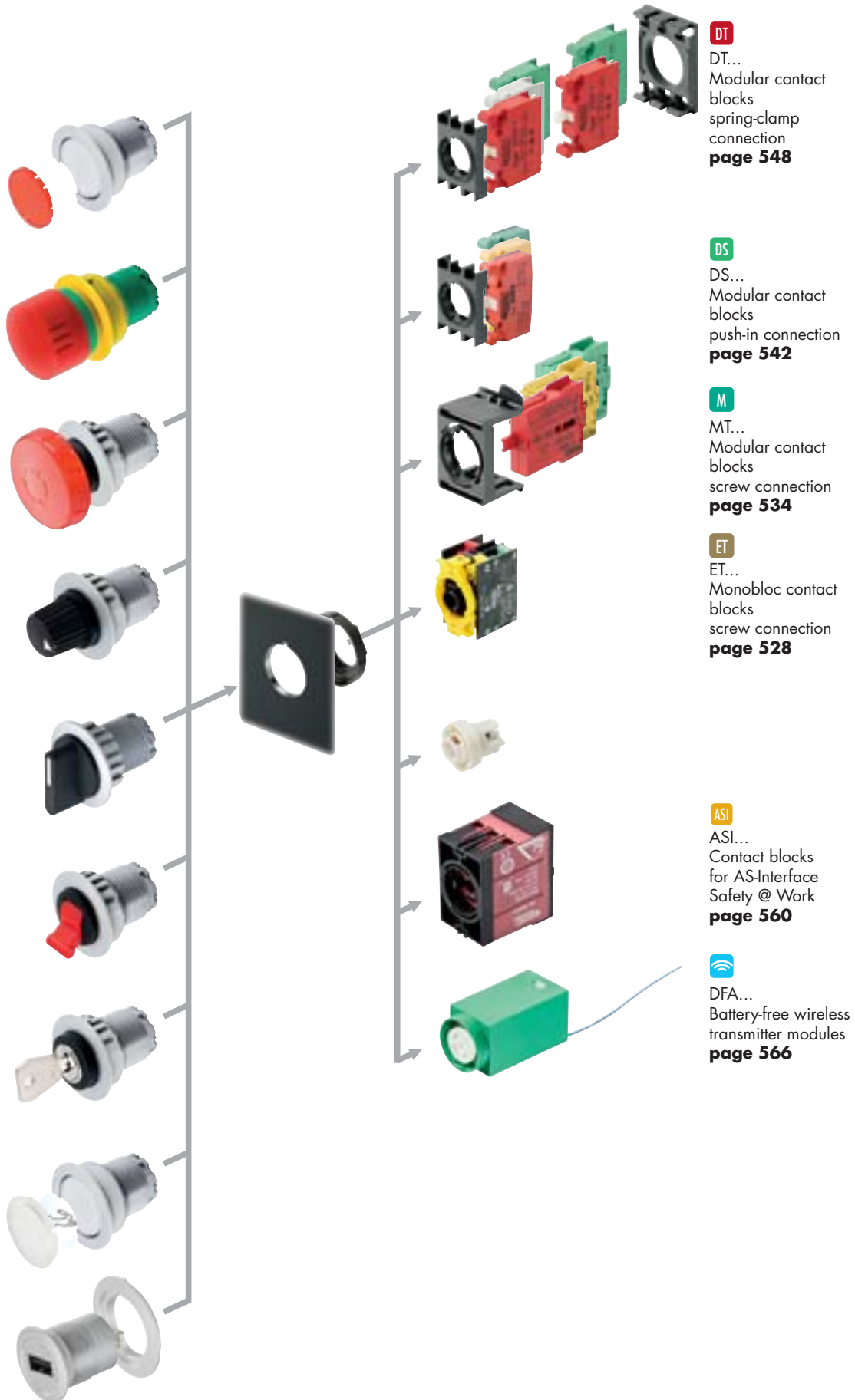

DT
DT...
Modular contact
blocks
spring-clamp
connection
page 548

DS
DS...
Modular contact
blocks
push-in connection
page 542

M
MT...
Modular contact
blocks
screw connection
page 534

ET
ET...
Monobloc contact
blocks
screw connection
page 528

ASI
ASI...
Contact blocks
for AS-Interface
Safety @ Work
page 560

DFA
DFA...
Battery-free wireless
transmitter modules
page 566

When combining the DT... contact blocks with key, selector and toggle heads,
please add ..._497 to the actuator type reference!

Mounting depth dimensions

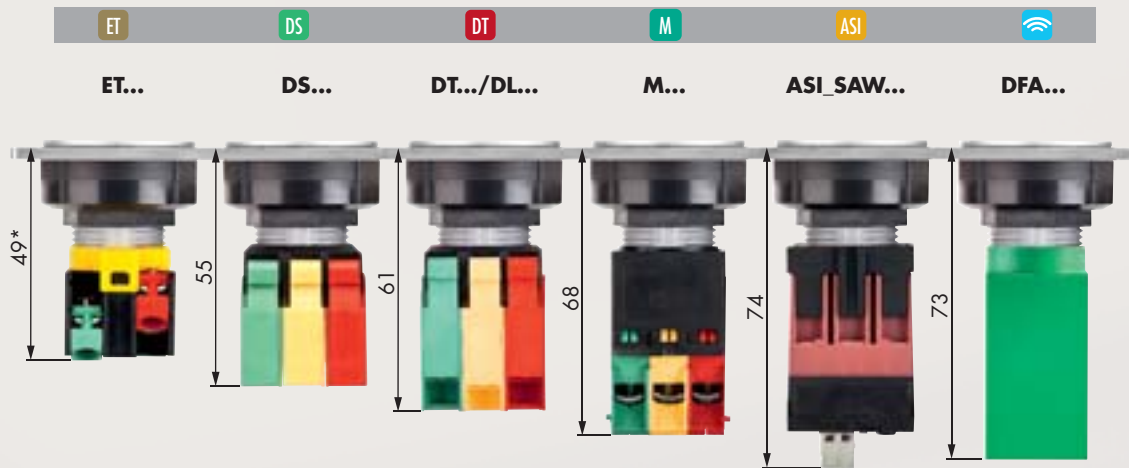

Cutout dimensions

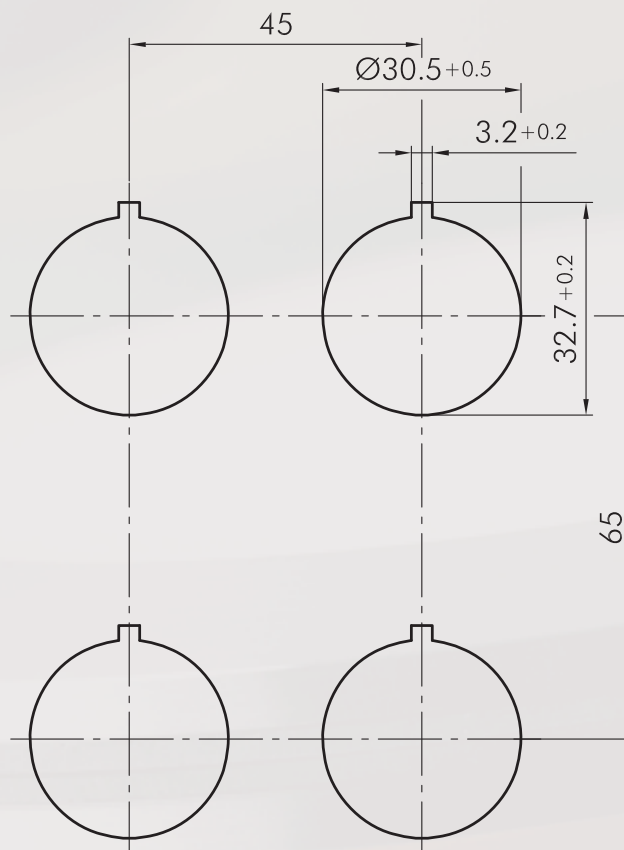

Mounting and service instructions

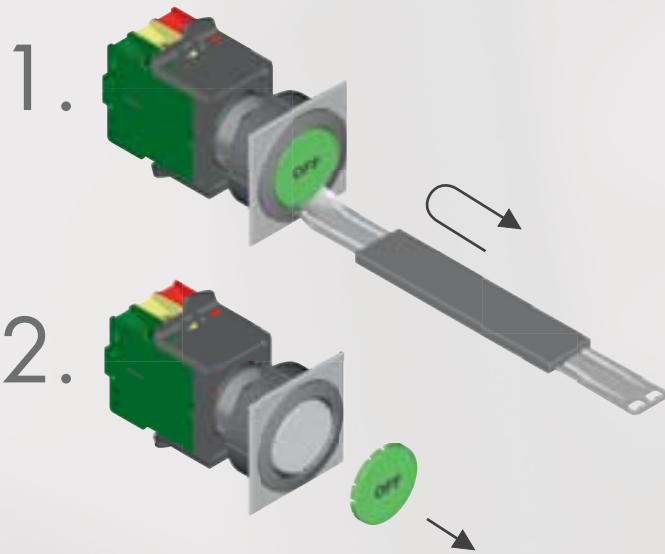

KOMBITAST®-R-JUWEL

Ø 30.5 mm

MADE IN GERMANY



About Us

Pushbuttons and Switches

Panel Mount Jacks

Emergency-Stop Buttons

Bus Technology

RFD

Enclosures

Pedal Switches

Terminal Blocks

Type Index

Pushbuttons

Illustration

Dimensions

Description

Type



6 mm

29.0





2.7

Ø36



0.8

Pushbutton head

suitable contact blocks:







front bezel:

silver-coloured		KRJMT
charcoal		KRJT
stainless steel, polished		KRJVAT

Accessories









Flat lens, transparent

colour:	blue		T30FBL
	yellow		T30FGB
	green		T30FGN
	clear		T30FKL
	red		T30FRT
	opal white		T30FWS







Flat lens, non-transparent

for pushbuttons without inscription and illumination

colour:	blue		T30FGBL
	yellow		T30FGGB
	green		T30FGGN
	white		T30FGWS
	black		T30FGSW
	red		T30FGRT







Convex lens, transparent

colour:	blue		T30DBL
	yellow		T30DGB
	green		T30DGN
	clear		T30DKL
	red		T30DRT



High lens, transparent

colour:	blue		T30HBL
	yellow		T30HGB
	green		T30HGN
	clear		T30HKL
	red		T30HRT

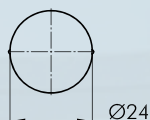

Nameplate with standard imprint

please specify index number (see nameplates from page 634)

BSKJ...

Pushbuttons

Illustration

Dimensions

Description

Type

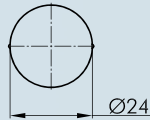

Nameplate with special imprint
according to customer's specification

BSKJB

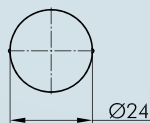

Blank nameplate

BSKJU

IP69K

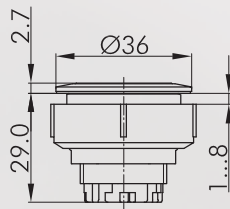

Pushbutton head with ring illumination

incl. lens, inscription on request

suitable contact blocks:



front bezel:

silver-coloured

stainless steel, polished

KRJMTLR

KRJVATLR

IP69K

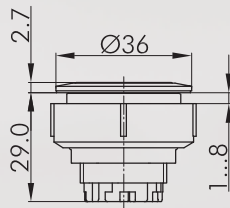

Pushbutton head with ring illumination and laser printing

incl. lens,
with laser printing, standard symbols see nameplates on page 634
(please specify index number)
special inscription on request

suitable contact blocks:



front bezel:

silver-coloured

stainless steel, polished

KRJMTLRL...

KRJVATLRL...

IP67

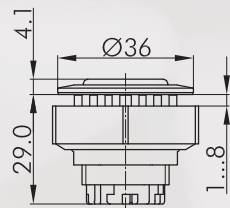

Membrane pushbutton head

with fully closed, transparent silicone cap, down to -50° C

suitable contact blocks:



front bezel:

silver-coloured

charcoal

stainless steel, polished

KRJMTM

KRJTM

KRJVATM

Accessories



Flat lens, transparent

colour:

blue

yellow

green

clear

red

opal white



T20FBL

T20FGB

T20FGN

T20FKL

T20FRT

T20FWS

KOMBITAST®-R-JUWEL

Ø 30.5 mm

MADE IN GERMANY



About Us

Pushbuttons and Switches

Panel Mount Locks

Emergency-Stop Buttons

Bus Technology

RFD

Enclosures

Pedal Switches

Terminal Blocks

Type Index

Emergency-Stops

Illustration

Dimensions

Description

Type

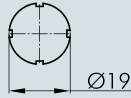

Nameplate with standard imprint

please specify index number(see nameplates from page 634)

BSRX...

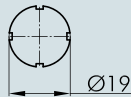

Nameplate with special imprint

according to customer's specification

BSRXB

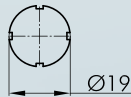

Blank nameplate

BSRXU

IP65

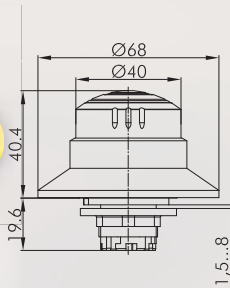

Emergency-stop head

Foolproof: yes
 Switching position indicator: yes
 Permissive Contact: no
 Anti-lock collar: yes
 Release: twist right or left
 Standard: EN 60947-5-1, EN 60947-5-5, EN ISO 13850



suitable contact blocks:



front bezel: yellow



Mushroom head: red



KRBUV70

IP65
IP67

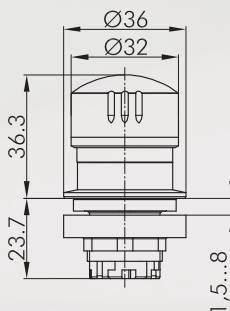

Emergency-stop head

Foolproof: yes
 Switching position indicator: yes
 Permissive Contact: no
 Anti-lock collar: no
 Release: twist right or left
 Standard: EN 60947-5-1, EN 60947-5-5, EN ISO 13850



suitable contact blocks:



front bezel: yellow



Mushroom head: red



KRJUV

Emergency-Stops

Illustration

Dimensions

Description

Type

IP65

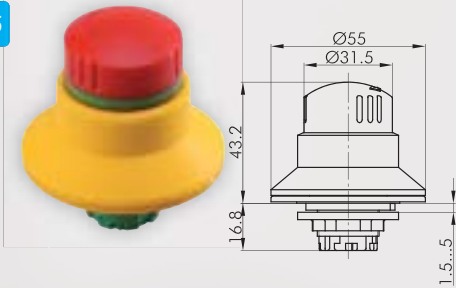

Emergency-stop head

consisting of QRBUV and adapter

Foolproof: yes
 Switching position indicator: yes
 Permissive Contact: no
 Anti-lock collar: yes
 Release: twist right or left
 Standard: EN 60947-5-1, EN 60947-5-5, EN ISO 13850

suitable contact blocks:

ASI DS DT ET M

front bezel: yellow

Mushroom head: red



KRBUV

IP65

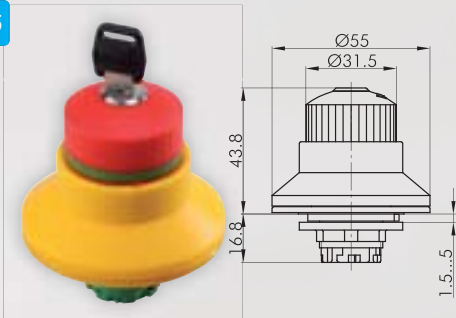

Emergency-stop head

consisting of QRBUVSE and adapter

Foolproof: yes
 Switching position indicator: yes
 Permissive Contact: no
 Anti-lock collar: yes
 Release: key release
 Standard: EN 60947-5-1, EN 60947-5-5, EN ISO 13850

suitable contact blocks:

ASI DS DT ET M

front bezel: yellow

Mushroom head: red



KRBUVSE



For further emergency-stops, please refer to the chapter "Emergency-Stop Head" starting on page 594

The emergency-stop heads can also be supplied as latching mushroom heads with mushrooms in different colours.

Mushroom Pushbuttons

Illustration

Dimensions

Description

Type

IP65

6 mm

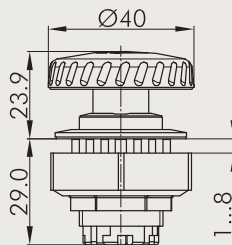

Mushroom head, latch-type

Foolproof: no
Switching position indicator: no
Permissive Contact: no
Anti-lock collar: no
Release: twist

suitable contact blocks:

ASI DS DT ET M

front bezel:	silver-coloured		
Mushroom head:	red		KRJMV
front bezel:	charcoal		
Mushroom head:	red		KRJV
front bezel:	stainless steel, polished		
Mushroom head:	red		KRJVAV

IP65

6 mm

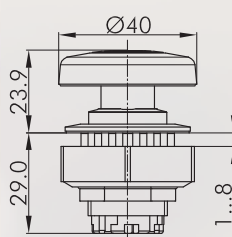

Mushroom head, momentary

other mushroom colours on request
Switching position indicator: no
Permissive Contact: no
Anti-lock collar: no

suitable contact blocks:

DS DT ET M

front bezel:	silver-coloured		
Mushroom head:	red		KRJMS
front bezel:	charcoal		
Mushroom head:	red		KRJS
front bezel:	stainless steel, polished		
Mushroom head:	red		KRJVAS

Knob Sets for Rotary Switches

Illustration

Dimensions

Description

Type

IP65

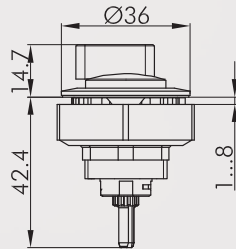

Knob set for rotary switches Kraus & Naimer
for Kraus & Naimer types CG4 and CA4

front bezel:

silver-coloured
charcoal



KRJMDAU
KRJDAU

IP65

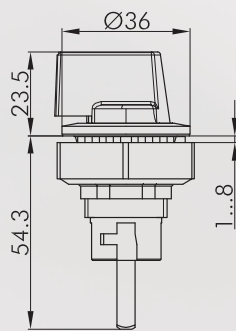

Knob set for rotary switches ELEKTRA Tailfingen

front bezel:

silver-coloured
anthracite



KRJMDAU_ET
KRJDAU_ET

IP65

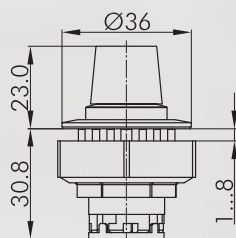

Knob set for potentiometers

for potentiometers of 6 mm shaft dia. and thread M10 x 0.75
delivery without potentiometer
shaft length: approx. 50 mm ± 2 mm incl. fastening thread

front bezel

silver-coloured
charcoal
stainless steel, polished



KRJMR
KRJJR
KRJVAR

KOMBITAST®-R-JUWEL

Ø 30.5 mm

MADE IN GERMANY



About Us

Selector Switches (momentary/maintained)

I = Switching position
> = Spring return

Pushbuttons and Switches

Panel Mount Jacks

Emergency-Stop Buttons

Bus Technology

RFD

Enclosures

Pedal Switches

Terminal Blocks

Type Index

Illustration

Dimensions

Description

Type

IP65

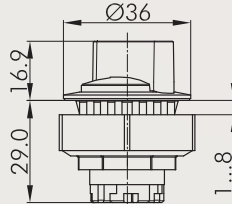

Selector head, maintained

suitable contact blocks:

DS DT ET M

front bezel: silver-coloured charcoal stainless steel, polished



KRJMWA
KRJWA
KRJVAWA

suitable contact blocks:

DT ET M

front bezel: silver-coloured charcoal stainless steel, polished



KRJMWB
KRJWB
KRJVAWB

IP65

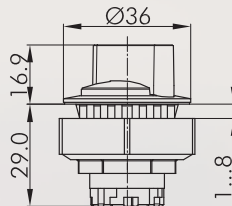

suitable contact blocks:

DS DT ET M

front bezel: silver-coloured charcoal stainless steel, polished



KRJMSTA
KRJSTA
KRJVASTA

suitable contact blocks:

DT ET M

front bezel: silver-coloured charcoal stainless steel, polished



KRJMSTB
KRJSTB
KRJVASTB

IP65

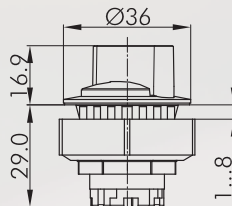

Selector head, left maintained, right momentary

suitable contact blocks:

DT ET M

front bezel: silver-coloured charcoal stainless steel, polished



KRJMWC
KRJWC
KRJVAWC

IP65

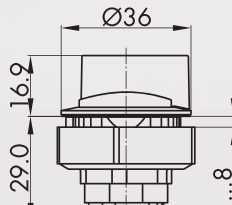

Selector head, maintained (two-piece plunger)

suitable contact blocks:

DS DT M

front bezel: silver-coloured charcoal



KRJMZWB
KRJZWB

Selector Switches (momentary/maintained)

I = Switching position
> = Spring return

Illustration

Dimensions

Description

Type

IP65

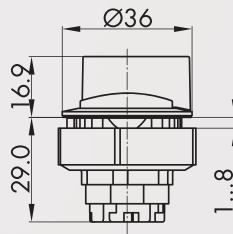

Selector head, momentary (two-piece plunger)

suitable contact blocks:

DS DT M

front bezel:

silver-coloured
charcoal



KRJMZSTB
KRJZSTB

IP65

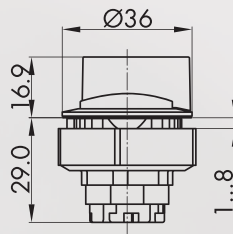

Selector head, left maintained, right momentary (two-piece plunger)

suitable contact blocks:

DS DT M

front bezel:

silver-coloured
charcoal



KRJMZWC
KRJZWC

IP65

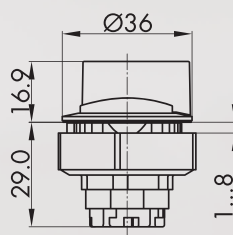

suitable contact blocks:

DS DT M

front bezel:

silver-coloured
silver-coloured



KRJMZWD
KRJZWD

IP65

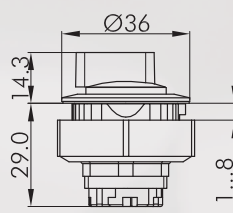

Illuminated selector head, maintained

inclusive five small transparent colour plates in red, yellow, green, white and blue

suitable contact blocks:

DS DT ET M

front bezel

silver-coloured
charcoal
stainless steel, polished



KRJMWAL
KRJWAL
KRJVWAL

suitable contact blocks:

DS DT ET M

front bezel:

silver-coloured
charcoal
stainless steel, polished



KRJMWBL
KRJWBL
KRJVWBL

KOMBITAST®-R-JUWEL

Ø 30.5 mm

MADE IN GERMANY



About Us

Selector Switches (momentary/maintained)

I = Switching position
> = Spring return

Pushbuttons and Switches

Panel Mount Jacks

Emergency-Stop Buttons

Bus Technology

RFD

Enclosures

Pedal Switches

Terminal Blocks

Type Index

Illustration

Dimensions

Description

Type

IP65

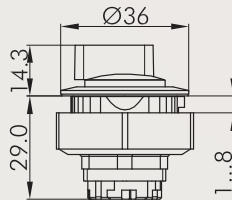

Illuminated selector head, left maintained, right momentary

inclusive four small transparent colour plates in red, yellow, green, white and blue

suitable contact blocks:

DS DT ET M

front bezel:

- silver-coloured
- charcoal
- stainless steel, polished



KRJMWCL
KRJWCL
KRJVAWCL

IP65

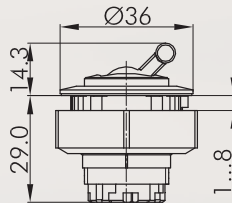

Toggle head

red toggle (other colours on request)

suitable contact blocks:

DS DT ET M

front bezel:

- silver-coloured
- charcoal
- stainless steel, polished



KRJMK
KRJK
KRJVAK

Key Switches (momentary/maintained)

I = Switching position
> = Spring return
O = Key removable position

Illustration

Dimensions

Description

Type

IP65

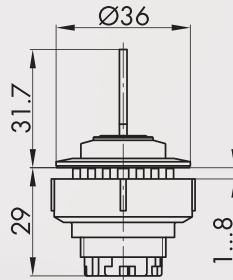

Key actuator, maintained

including two keys
other lock types on request

suitable contact blocks:

DT ET M

front bezel:

silver-coloured
charcoal
stainless steel, polished

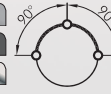

KRJMSA12E
KRJSSA12E
KRJVASSA12E

suitable contact blocks:

DT ET M

front bezel:

silver-coloured
charcoal
stainless steel, polished

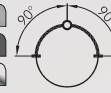

KRJMSA13E
KRJSSA13E
KRJVASSA13E

suitable contact blocks:

DS DT ET M

front bezel:

silver-coloured
charcoal
stainless steel, polished



KRJMSA14E
KRJSSA14E
KRJVASSA14E

suitable contact blocks:

DS DT ET M

front bezel:

silver-coloured
charcoal
stainless steel, polished



KRJMSA15E
KRJSSA15E
KRJVASSA15E

suitable contact blocks:

DS DT ET M

front bezel

silver-coloured
charcoal
stainless steel, polished



KRJMSA17E
KRJSSA17E
KRJVASSA17E

suitable contact blocks:

DS DT ET M

front bezel:

silver-coloured
charcoal
stainless steel, polished



KRJMSA18E
KRJSSA18E
KRJVASSA18E

KOMBITAST®-R-JUWEL

Ø 30.5 mm

MADE IN GERMANY



About Us

Key Switches (momentary/maintained)

I = Switching position
> = Spring return
O = Key removable position

Illustration

Dimensions

Description

Type

IP65

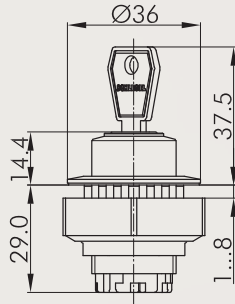

Key actuator, momentary

including two keys
other lock types on request

suitable contact blocks:

DT ET M

front bezel: silver-coloured charcoal stainless steel, polished



KRJMSA23E
KRJSSA23E
KRJVASSA23E

suitable contact blocks:

DS DT ET M

front bezel: silver-coloured charcoal stainless steel, polished



KRJMSA27E
KRJSSA27E
KRJVASSA27E

IP65

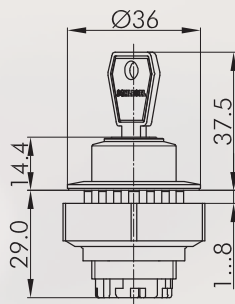

Key actuator, left maintained, right momentary

including two keys
other lock types on request

suitable contact blocks:

DT ET M

front bezel: silver-coloured charcoal stainless steel, polished



KRJMSA24E
KRJSSA24E
KRJVASSA24E

IP65

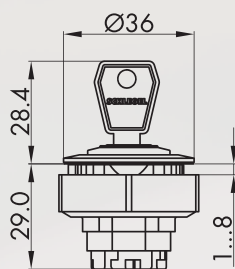

Key actuator, maintained (two-piece plunger)

including two keys
other lock types on request

suitable contact blocks:

DS DT M

front bezel: silver-coloured charcoal

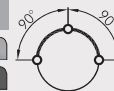

KRJMZSA12E
KRJZSA12E

suitable contact blocks:

DS DT M

front bezel: silver-coloured charcoal



KRJMZSA13E
KRJZSA13E

IP65

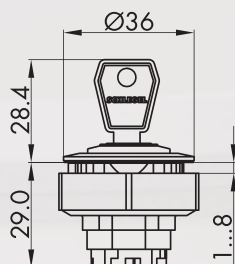

suitable contact blocks:

DS DT M

front bezel: silver-coloured charcoal



KRJMZSA23E
KRJZSA23E

Pushbuttons and Switches

Panel Mount Jacks

Emergency-Stop Buttons

Bus Technology

RFD

Enclosures

Pedal Switches

Terminal Blocks

Type Index

Key Switches (momentary/maintained)

I = Switching position
> = Spring return
O = Key removable position

Illustration

Dimensions

Description

Type

IP65

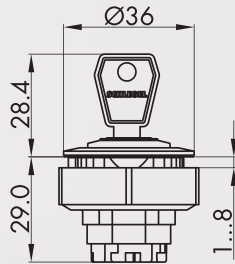

suitable contact blocks:

DS DT M

front bezel:

silver-coloured
charcoal



KRJMZSSA24E
KRJZSSA24E

Accessories



Spare key (standard)

standard spare key, specify key number for special locks

ESE845



Adapter for panel mount jacks

allows true-to-size mounting of all flush-mounted jacks of the Rontron-R-Juwel series into cut-outs of 30.5 mm dia., the jack is not included in delivery

suitable jacks:



colour:

silver-coloured



KRJM22R

**For panel mount jacks,
please refer to page 572**



A propos de nous
Appareils de commande
→ Têtes de commande
Traversées de cloison
Tête de bouton d'arrêt d'urgence
Systèmes interface bus de terrain
RFID
Boîtiers
Interrupteurs à pédale
Blocs de jonction
Index

KOMBITAST®-R-JUWEL

Ø 30.5 mm

MADE IN GERMANY



About Us

Pushbuttons and Switches

Panel Mount Jacks

Emergency-Stop Buttons

Bus Technology

RFD

Enclosures

Pedal Switches

Terminal Blocks

Type Index

Pilot Lights

Illustration

Dimensions

Description

Type

IP65

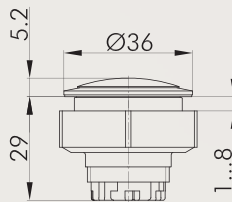

Pilot light head

suitable lampholders:

DS DT ET M

front bezel:

silver-coloured
charcoal
stainless steel, polished



KRJMN
KRJN
KRJVAN

Accessories



Convex lens

colour:

blue
yellow
green
clear
red
opal white



K30DBL
K30DGB
K30DGN
K30DKL
K30DRT
K30DWS

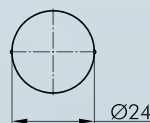

Nameplate with standard imprint

please specify index number(see nameplates from page 634)

BSKJ...

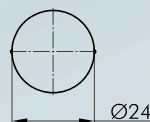
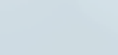

Nameplate with special imprint

according to customer's specification

BSKJB

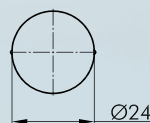

Blank nameplate

BSKJU

Pilot Lights

Illustration

Dimensions

Description

Type

IP65

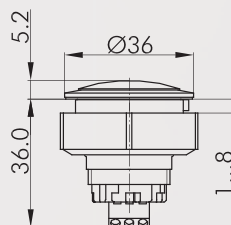

Two-colour LED pilot light 24V

operating temperature: -25°C ... 60°C
 rated voltage: 24V DC
 rated current: max. 10mA per LED
 rated insulation voltage: 60V
 pollution degree: 2
 overvoltage category: II
 connection: screw terminals 3x 0.14...1 mm²
pin arrangement
 pin 1: rouge
 pin 2: GND
 pin 3: green
 other colours on request
 incl. lens and nameplate

front bezel:	silver-coloured		
LED colour:	red/green		KRJML_24R_G
front bezel:	charcoal		
LED colour:	red/green		KRJL_24R_G
front bezel:	stainless steel, polished		
LED colour:	red/green		KRJVAL_24R_G

IP65

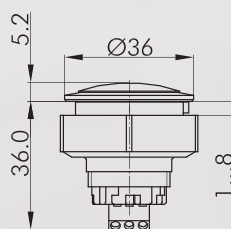

Two-colour LED pilot light 230V

operating temperature: -25°C ... 45°C
 rated voltage: 230V AC / 50 ... 60Hz
 rated current: max. 5mA per LED
 pollution degree: 2
 overvoltage category: II
 connection: screw terminals 3x 0.2...2.5 mm²
 (flexible/rigid)
pin arrangement
 pin 1: rouge
 pin 2: GND
 pin 3: green
 other colours on request
 incl. lens and nameplate

front bezel:	silver-coloured		
LED colour:	red/green		KRJML_230R_G
front bezel:	charcoal		
LED colour:	red/green		KRJL_230R_G
front bezel:	stainless steel, polished		
LED colour:	red/green		KRJVAL_230R_G

Accessories













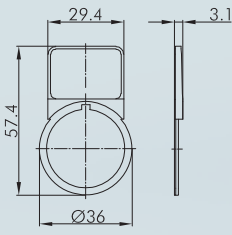

Mounting tool 22

S22

with torque limitation
 for the series QUARTEX-R-(JUWEL), KOMBITAST-R-JUWEL,
 RONDEX, RONDEX-M, RONDEX-JUWEL, RVA, DUX-Basic,
 SHORTRON, jacks of the ranges RONTRON-R-/Q-JUWEL

Accessories for Pushbuttons and Switches

Illustration	Dimensions	Description	Type
		Mounting tool adapter with 1/4" connections for mounting tools S16 and S22	SRA
		External nameplate holder for outside marking of the actuators of the KOMBITAST-R-JUWEL series, accepts self-adhesive nameplates colour: silver-coloured  charcoal 	KRJMABT KRJABT
		Self-adhesive nameplate, laser-printed inscription according to customer's specification dimensions: 19 x 27 mm	BZ23L...
		Self-adhesive nameplate blank dimensions: 19 x 27 mm	BZ23U
		Self-adhesive nameplate with standard imprint please specify index number(see nameplates from page 634) dimensions: 19 x 27 mm	BZ23B...
		Yellow nameplate self-adhesive PVC foil printing on request outer dia. 75 mm for mounting dia. 30,5 mm colour: yellow 	NAS_30
		Yellow nameplate with quadrilingual imprint self-adhesive PVC foil outer dia.75 mm for mounting dia. 30,5 mm colour: yellow 	NAS_30_548

Accessories for Pushbuttons and Switches

Illustration	Dimensions	Description	Type
		Lead-sealable protective lid for pushbutton KRJMT(LR)/KRJT/KRJVAT(LR) colour: transparent	 KDKRT
		Lead-sealable protective lid for selector switches KRJMWA/KRJWA/KRJVAWA lid: transparent	 KDKRWA
		Lead-sealable protective lid for selector switches KRJMWB/KRJWB/KRJVAWB colour: transparent	 KDKRWB
		Universal lens remover	USK
 IP65		Dummy to close unused mounting apertures colour: silver-coloured charcoal	 BVKRJM BVKRJ

About Us

→ Pushbuttons and Switches

Panel Mount Jacks

Emergency-Stop Buttons

Bus Technology

RFID

Enclosures

Pedal Switches

Terminal Blocks

Type Index